

# Technical data sheet



## Product features

### Food display island chilled GN 3-1/1 Wenge

<b>Model</b>	<b>SAP Code</b>	00012099
--------------	-----------------	----------



- Buffet type: BLUE - cooled, dynamic cooling
- Device properties: Chilled
- Number of GN / EN: 3
- GN / EN size in device: GN 1/1
- GN device depth: 150
- Minimum device temperature [°C]: 4
- Maximum device temperature [°C]: 8

<b>SAP Code</b>	00012099	<b>Loading</b>	230 V / 1N - 50 Hz
<b>Net Width [mm]</b>	1169	<b>Number of GN / EN</b>	3
<b>Net Depth [mm]</b>	760	<b>GN / EN size in device</b>	GN 1/1
<b>Net Height [mm]</b>	1288	<b>GN device depth</b>	150
<b>Net Weight [kg]</b>	121.80	<b>Minimum device temperature [°C]</b>	4
<b>Power electric [kW]</b>	0.247	<b>Maximum device temperature [°C]</b>	8

# Technical data sheet



Technical drawing

Food display island chilled GN 3-1/1 Wenge

Model

SAP Code

00012099

A= ELECTRICAL CONNECTION  
 D= WATER DISCHARGE Ø16  
 E= GAS CONNECTION Ø8 Ø10  
 F= WATER BOX

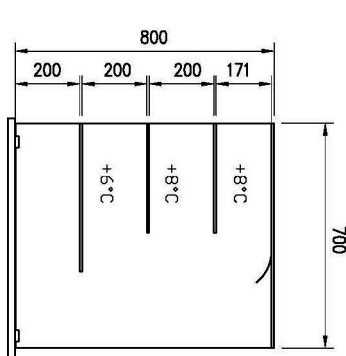
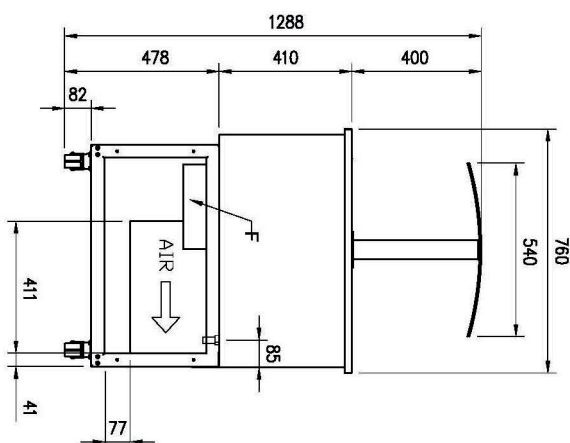
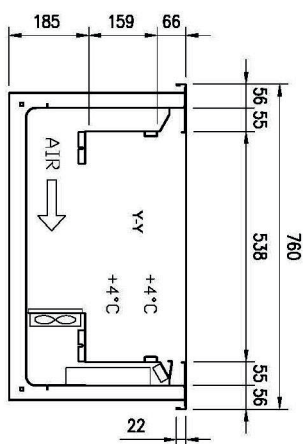
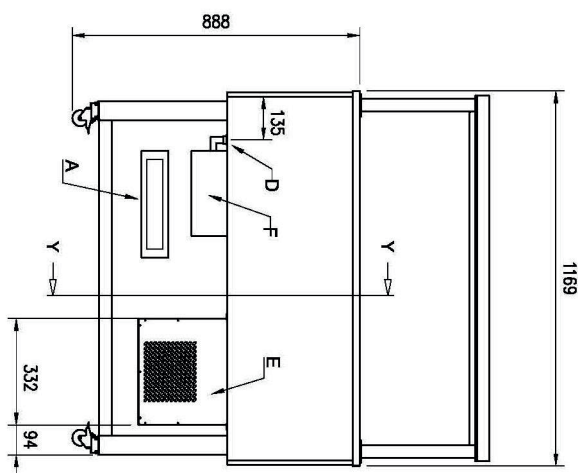
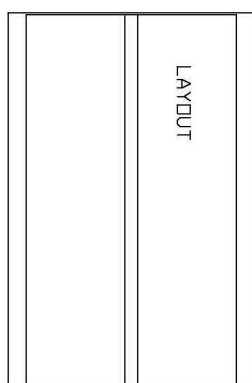

PLATINUM

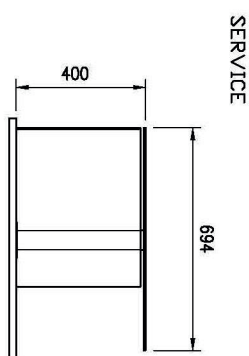

SERVICE

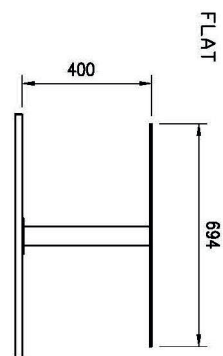

FLAT

# Technical data sheet



## Product benefits

### Food display island chilled GN 3-1/1 Wenge

Model

SAP Code

00012099

1

#### Dynamic cooling

constant temperature in all places of the refrigerated space

- greater hygienic safety of chilled food

2

#### All-stainless steel construction

harmless to health for contact with food  
robustness

- perfect sanitation
- long service life

3

#### Rounded corners

basins without sharp edges and corners

- higher hygienic safety
- time saving due to easy cleaning

4

#### GN insertion up to 150mm

variability of use

- possibility of cooling different types of food and larger volumes
- saving time, space, costs

5

#### LED lighting

variability of use

- economical lighting
- attractive appearance

6

#### Travel wheels

portable buffet table

- greater flexibility in dispensing
- possibility of use at banquets
- easier and safer handling

7

#### Breathing galley with trigger

galerka made of hygienic Plexiglas with motorized displacement

- hygienic food protection
- the possibility of sealing before dispensing - extending the shelf life of food

# Technical data sheet



## Technical parameters

### Food display island chilled GN 3-1/1 Wenge

Model

SAP Code

00012099

**1. SAP Code:**

00012099

**2. Net Width [mm]:**

1169

**3. Net Depth [mm]:**

760

**4. Net Height [mm]:**

1288

**5. Net Weight [kg]:**

121.80

**6. Gross Width [mm]:**

1233

**7. Gross depth [mm]:**

1012

**8. Gross Height [mm]:**

1100

**9. Gross Weight [kg]:**

136.00

**10. Device type:**

Electric unit

**11. Buffet type:**

BLUE - cooled, dynamic cooling

**12. Device properties:**

Chilled

**13. Device color:**

Hemlock

**14. Power electric [kW]:**

0.247

**15. Loading:**

230 V / 1N - 50 Hz

**16. Number of GN / EN:**

3

**17. GN / EN size in device:**

GN 1/1

**18. GN device depth:**

150

**19. Minimum device temperature [°C]:**

4

**20. Maximum device temperature [°C]:**

8